

도시물순환 기술백서

스마트그린도시

LID 설계가이드 10선

어스그린코리아(주) Vol.03

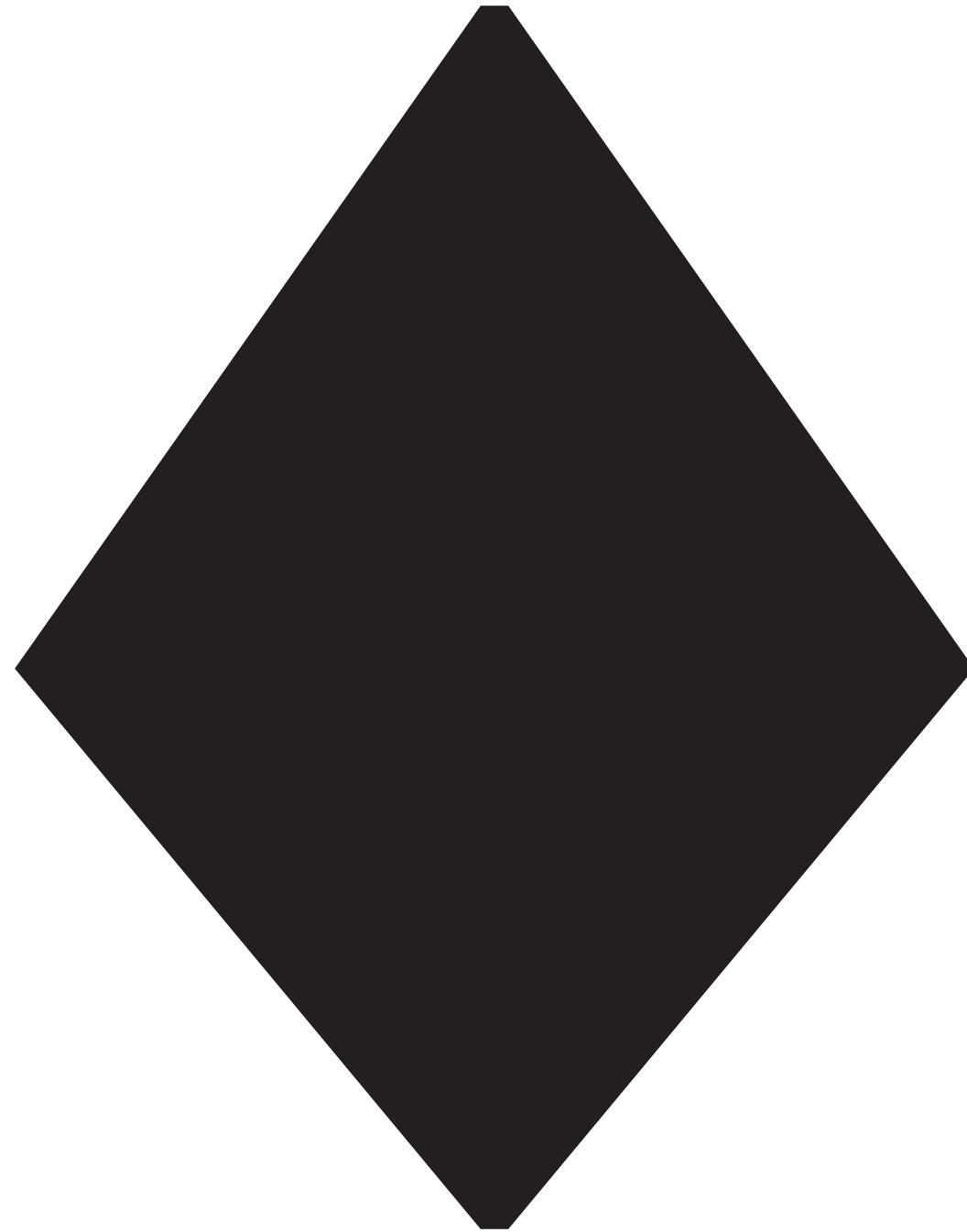

스마트그린도시

LID 설계가이드 10선

#그린뉴딜은 어스그린코리아(주)

어스그린코리아(주)는 지속가능한 《한국형_그린뉴딜》 실현을 위한
자원재활용 빗물관리 시스템 공법으로
고부가가치형 스마트그린도시 구축 가이드라인을 제시합니다.



Earth Green Korea

설계가이드 개요

OUTLINE

지속가능한 스마트그린도시 최적화 모델

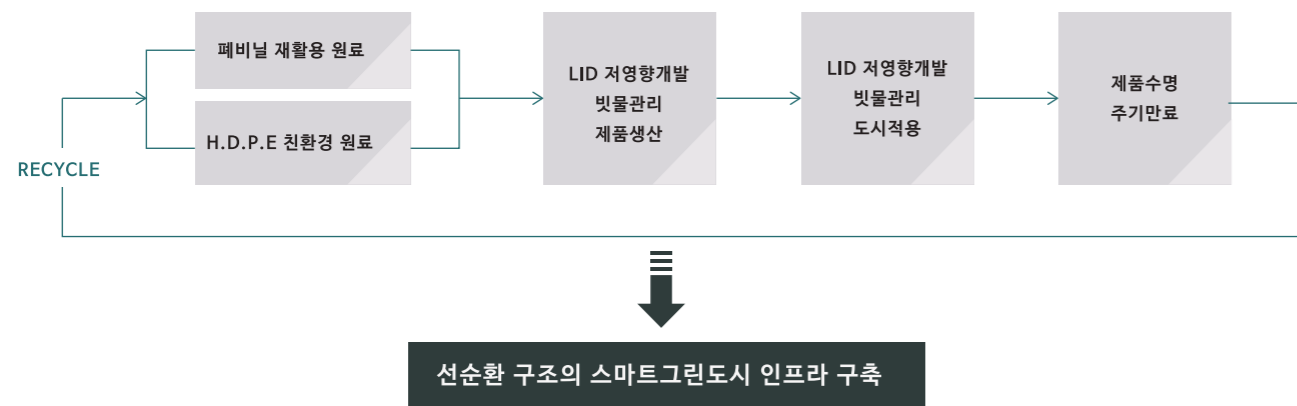

물순환시스템 기술접목 스마트그린도시 사업효과

기 대 효 과	효과분야	성과지표	수치	단위
	물환경		· 저류를 통한 강우유출수 처리	5
		· 초기우수 처리를 통한 비점오염 물질 농도 저감	30	%
		· 빗물저류를 통한 안정적 수자원 확보	200	ton
대기환경		· 포장면의 비산먼지 농도 저감	20	%
		· 대기질 정화를 통한 NO ₂ , SO ₂ , O ₃ 흡수	30	%
		· 소음저감 (방음 및 흡음) 효과	15	dB
생태환경		· 녹지조성에 따른 온실가스 (탄소) 감축	45	%
		· 녹화구간 지면 온도 저감 효과	15	℃
		· 그린인프라조성을 통한 공공이용시설 확대	20	%



설계가이드 10선

CONTENTS

01

빗물침투
생육삼통관

PAGE 08~12



06

빗물순환
빗물저금통

PAGE 48~50



02

빗물침투
가로수보호판

PAGE 14~20



07

빗물순환
생태보행로 시스템

PAGE 52~58



03

빗물침투
띠녹지보호판

PAGE 22~28



08

빗물순환
옥상녹화 시스템

PAGE 60~64



04

빗물침투
측구 배수로

PAGE 30~32



09

빗물순환
천연잔디운동장 시스템

PAGE 66~70



05

빗물저장
천연잔디보호매트

PAGE 34~46



10

빗물순환
벽면녹화 시스템

PAGE 72~76



SMART GREEN CITY
스마트그린도시 10선



1

빗물침투
생육삼통관

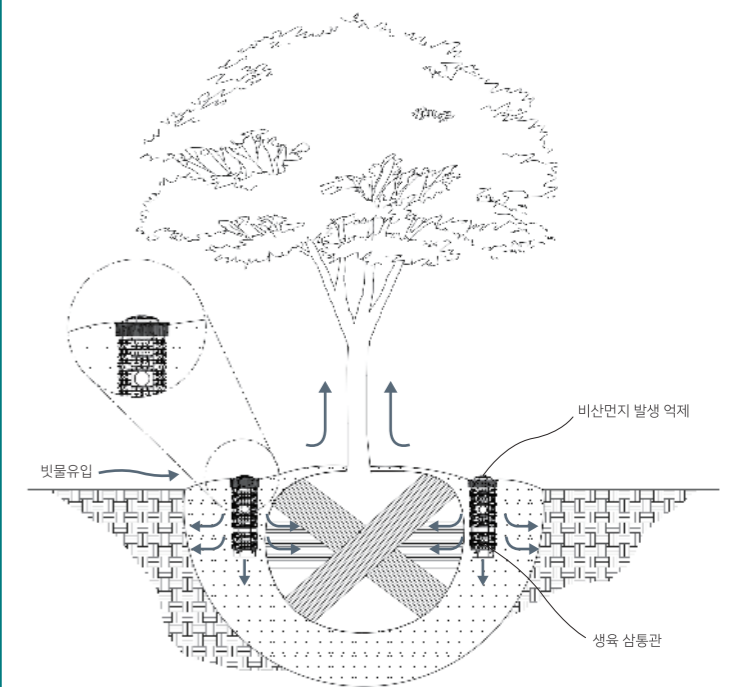

빗물침투 생육삼통관

제품명	빗물침투 생육삼통관
규격	(W)Ø100 x (H)300,400,500 (W)Ø120 x (H)350,650,950
재질	(일체형)P.V.C (조립형)페비닐재활용재
용도	과·수목, 녹지대 생육개선 장치
기능	도시물순환 LID제품 -빗물, 양분, 공기 공급 -토양 개량 효과 -잔뿌리 발달 탁월 -도심침수 완화
조달단가	5,700원~10,600원 [77page]
물품식별번호	[벤처나라] 22766994~22766996 24414795~24414796

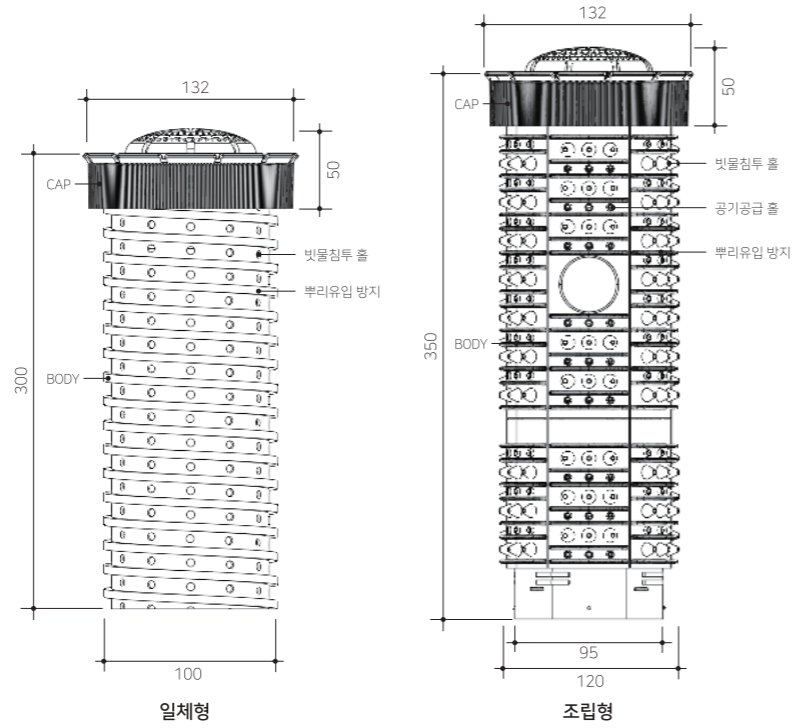

상세도면

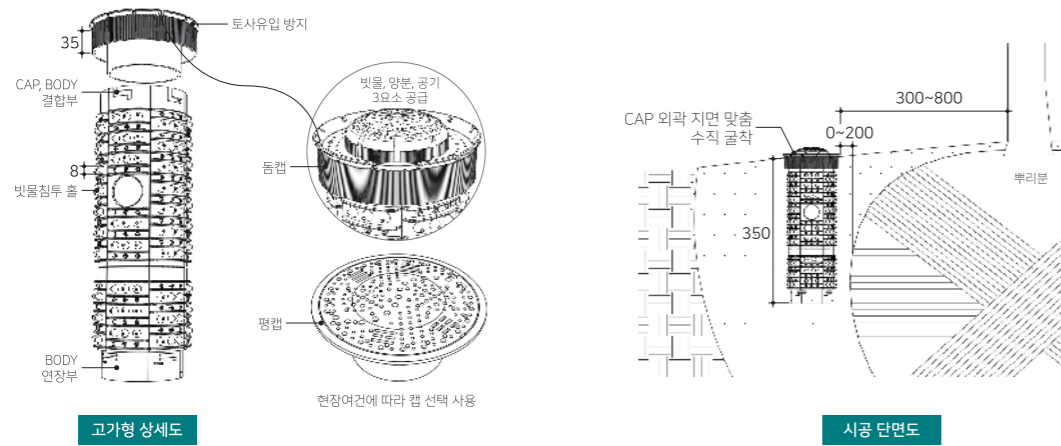



서울시 여의도 한강시민공원 (환경부 기후변화주간 나무심기 행사) 19' 4.



UAE(아랍에미리트) 각 토호국 시청 보행로 19' 11.



서울시 중구 서울로 7017 옥상정원 17' 9.



인천시 서구 아래뱃길 21' 7.

SMART GREEN CITY
스마트그린도시 10선



2

빗물침투
가로수보호판

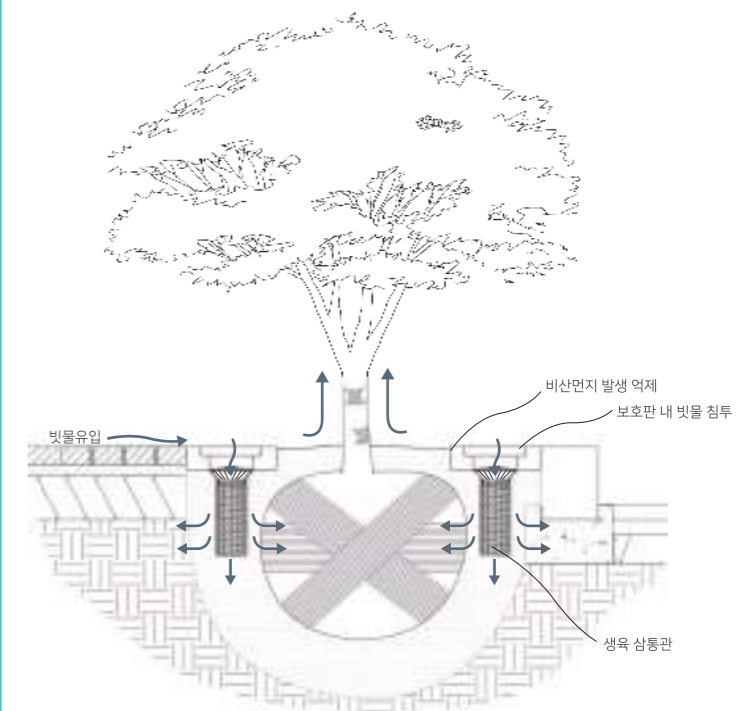

제품명	(AL)빗물침투 가로수보호판
규격	(W,L)현장맞춤 x (H)80
재질	(보호틀)알루미늄 x (보호판)H.D.P.E 페비닐재활용재 WV 고순도 페비닐재활용재 REV
용도	가로수 보호·생육개선 장치
기능	도시물순환 LID제품 -빗물, 양분, 공기 공급 -보행환경 환경 개선 -비산먼지 발생 억제 -도심침수 완화

조달단가 219,000원~747,000원 [77page]

물품식별번호 [나라장터] 틀, 판, 상통관 세트
23262343~23262356
24711240~24711250
[혁신장터] 틀, 판, 상통관 개별 주문
24318652~24318693

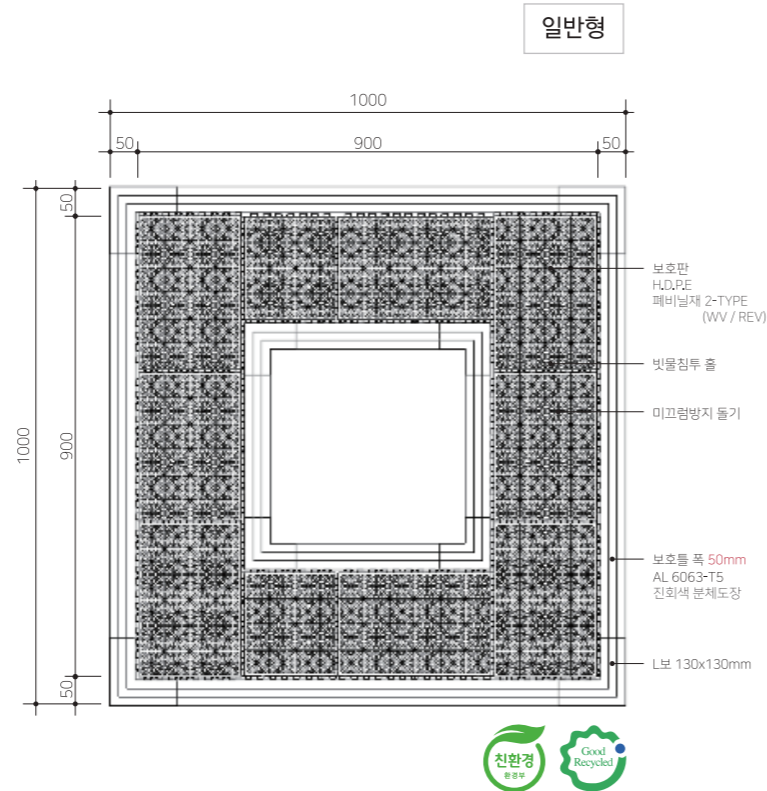

상세도면

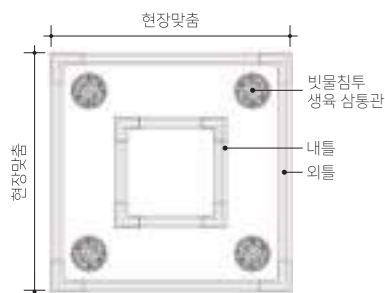

내부 평면도

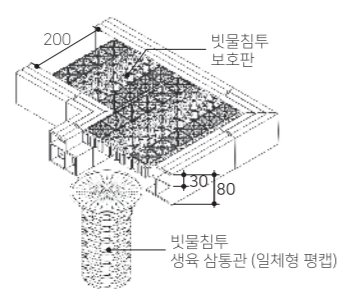

부분 상세도

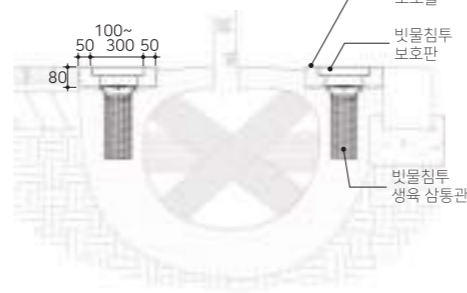

시공 단면도



기본형SQ (H.D.P.E)



기본형SQ (페비닐재 WV)



기본형C (H.D.P.E)





서울시 구로구 LID 저영향개발 생태보행로 19' 7.



인천시 연수구 새말로 22' 10.



부산시 사하구 하단유수지 22' 9.



부산시 해운대구 좌동순환로 22' 8.

빗물침투 가로수보호판 B type

고급형

제품명	(SL)빗물침투 가로수보호판
규격	(W,L)현장맞춤 x (H)60
재질	(보호틀)알루미늄 x (보호판) H.D.P.E 페비닐재활용재 WV 고순도 페비닐재활용재 REV 해미석 우드칩
용도	가로수 보호·생육개선 장치
기능	도시물순환 LID제품 -빗물, 양분, 공기 공급 -보행환경 환경 개선 -비산먼지 발생 억제 -도심침수 완화

조달단가 285,000원~615,000원 [80page]

물품식별번호 [나라장터] 톨, 판, 상통관 세트
24534456~24657263
[혁신장터] 톨, 판, 상통관 개별 주문
23913585~23913599

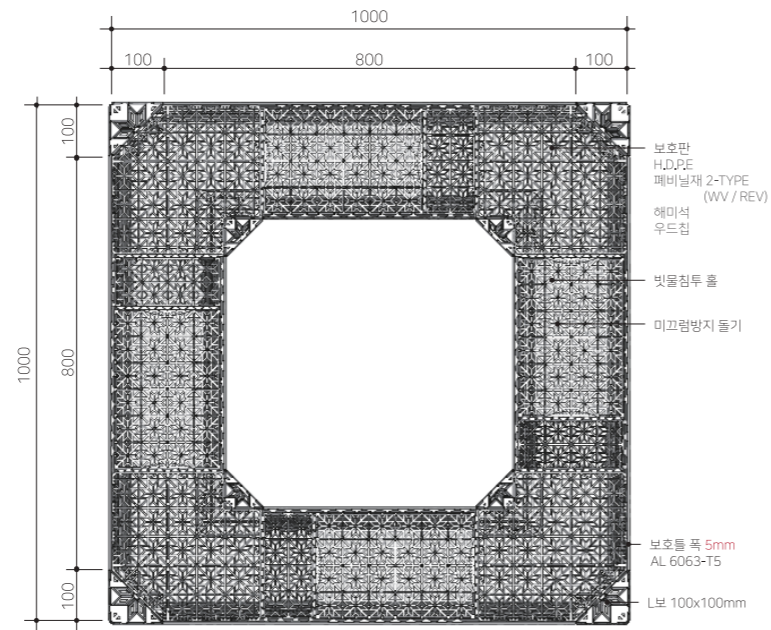

상세도면

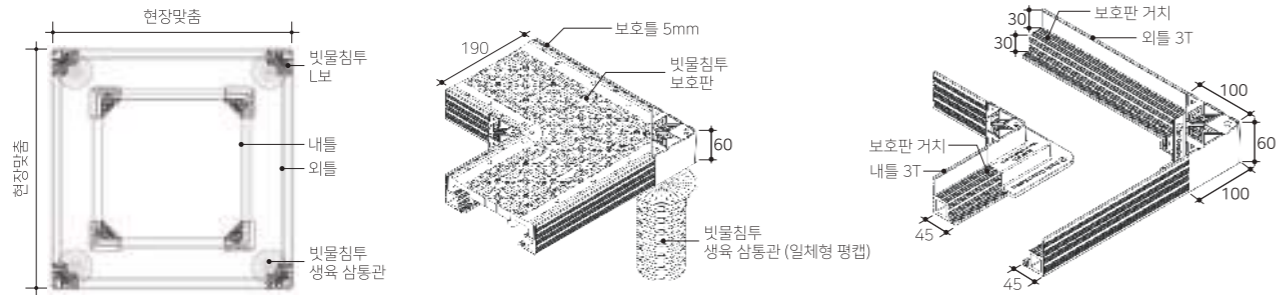

내부 평면도

부분 상세도

틀+엘보 상세도



슬림형SQ (페비닐재 REV)



슬림형SQ (페비닐재 WV)



슬림형SQ (해미석)



슬림형SQ (우드칩)



SMART GREEN CITY
스마트그린도시 10선



3

빗물침투
띠녹지보호판

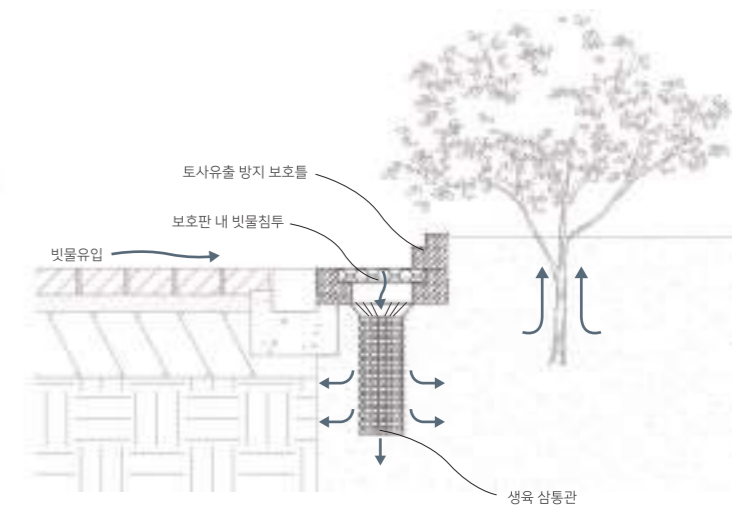

빗물침투 띠녹지보호판 A type

제품명	(AL)빗물침투 띠녹지보호판
규격	(W)200,300 x (H)80
재질	(보호틀)알루미늄 x (보호판) H.D.P.E 페비닐재활용재 WV 고순도 페비닐재활용재 REV
용도	가로화단 보호·생육개선 장치
기능	도시물순환 LID제품 -빗물, 양분, 공기 공급 -쾌적한 녹지환경 조성 -비산먼지 발생 억제 -도심침수 완화

조달단가 86,000원~150,800원 / M [80page]

물품식별번호 [나라장터] 틀, 판, 삼통관 세트
23262357~23262358
[혁신장터] 틀, 판세트 / 삼통관 개별 주문
24318653~24318654

상세도면

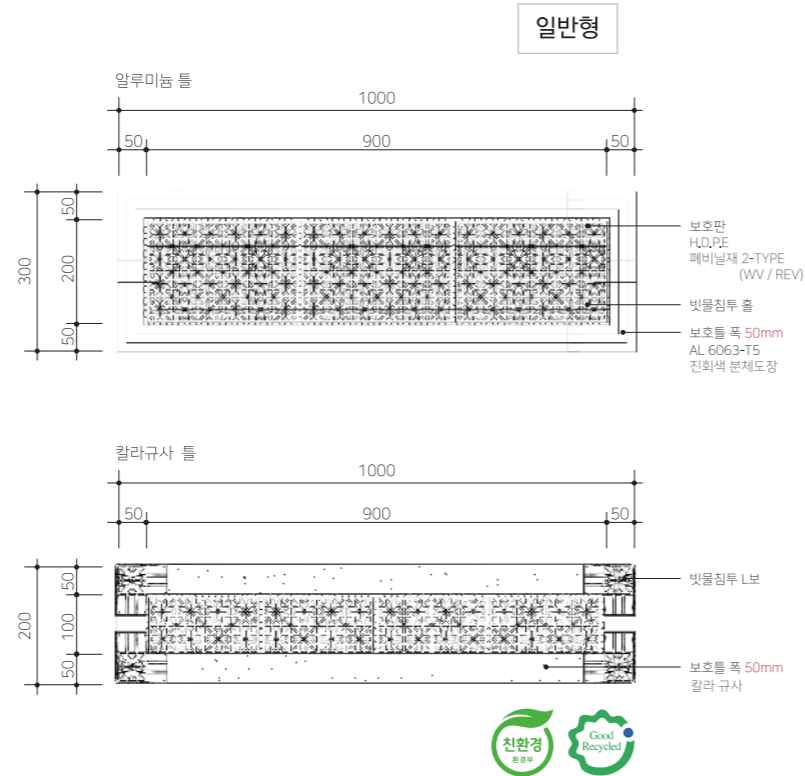
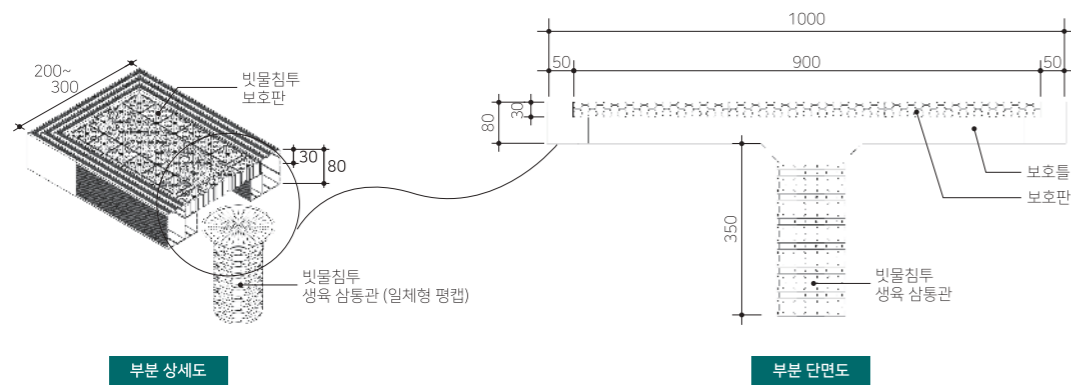



서울시 구로구 아름다운 거리 19' 7.



순천시 순천만생태문화교육원 앞 19' 11.



서울시 강서구 강서로 LID 저영향개발 생태보행로 20' 8.



경기도 오산시 문화회관 앞 20' 05.

빗물침투 띠녹지보호판 B type

제품명	빗물침투 띠녹지보호판
규격	(W)100 x (L)1000 x (H)100
재질	(보호틀)알루미늄 x (보호판)H.D.P.E 고순도 폐비닐재활용재 REV 고강도 알루미늄
용도	경계석 대응 빗물도랑 트렌치
기능	도시물순환 LID제품 -빗물, 양분, 공기 공급 -쾌적한 녹지환경 조성 -비산먼지 발생 억제 -도심침수 완화

조달단가 112,000원~147,000원 / M [80page]

물품식별번호 [나라장터] 띠녹지, 상통관 세트 24504138
[혁신장터] 띠녹지, 상통관 개별 주문 24294879

고급형

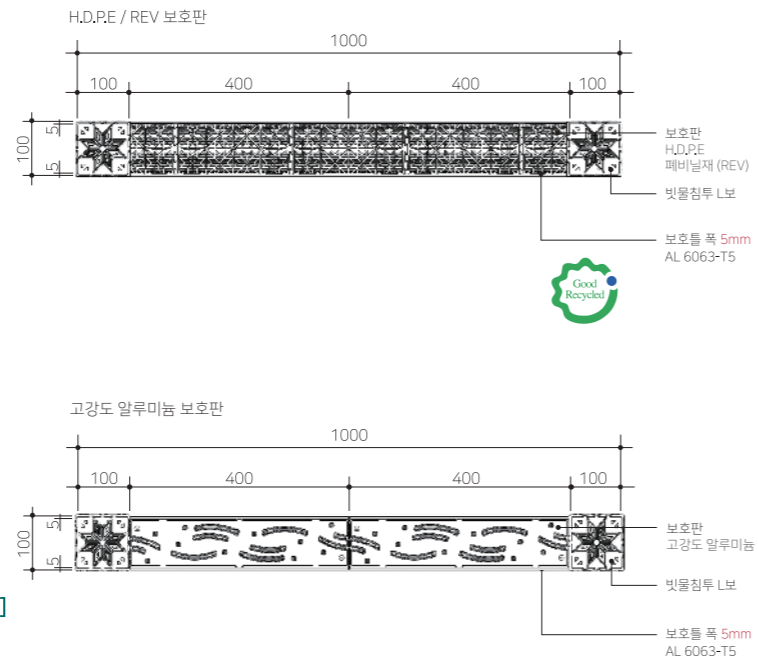

상세도면

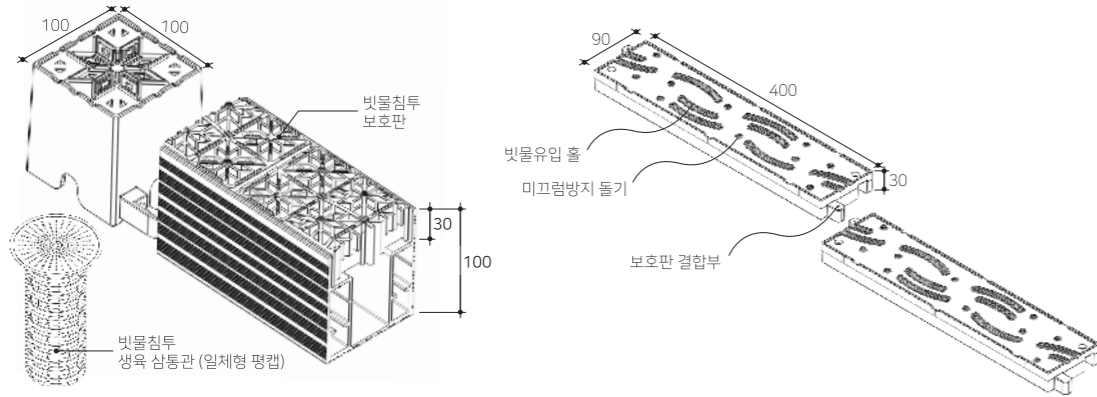

부분 상세도

보호판 결합 상세도



SMART GREEN CITY
스마트그린도시 10선



4

빗물침투
측구 배수로

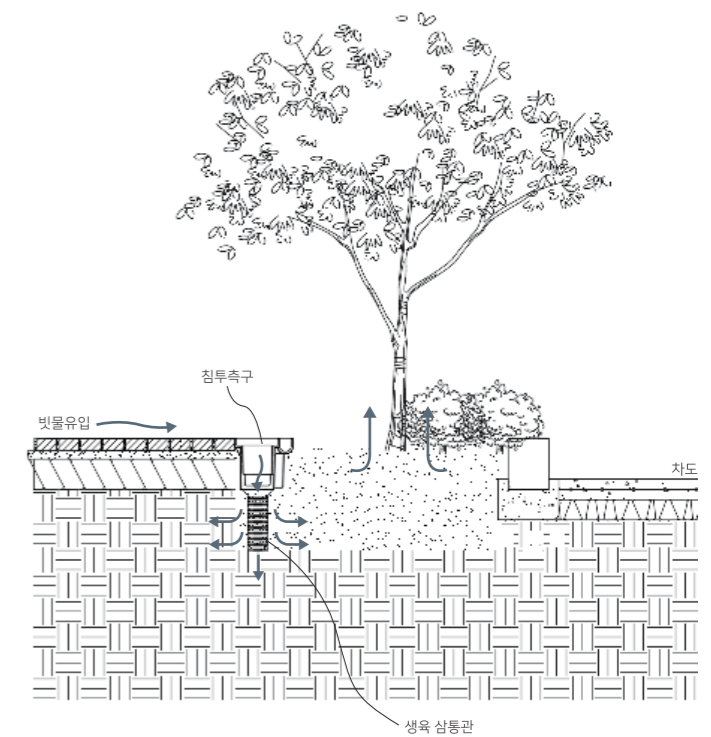

빗물침투 측구 배수로

제품명	빗물침투 측구 배수로
규격	(W)300 x (H)173
재질	(배수로)페비닐재 x (보호판)H.D.P.E 페비닐재활용재 WV 고순도 페비닐재활용재 REV
용도	도시 실개천 조성
기능	도시물순환 LID제품 -물고임 방지 -강우 유출 저감 -도시 미관 향상 -자원순환성 향상
단가	19,500원~45,000원 / M

상세도면

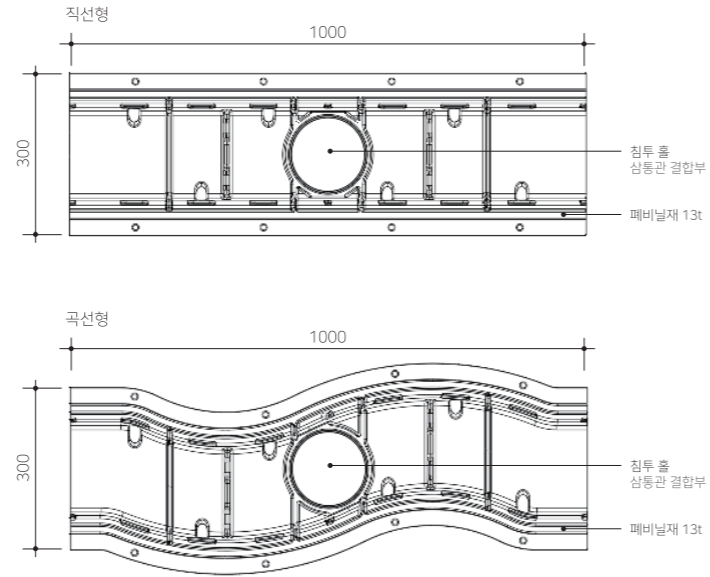
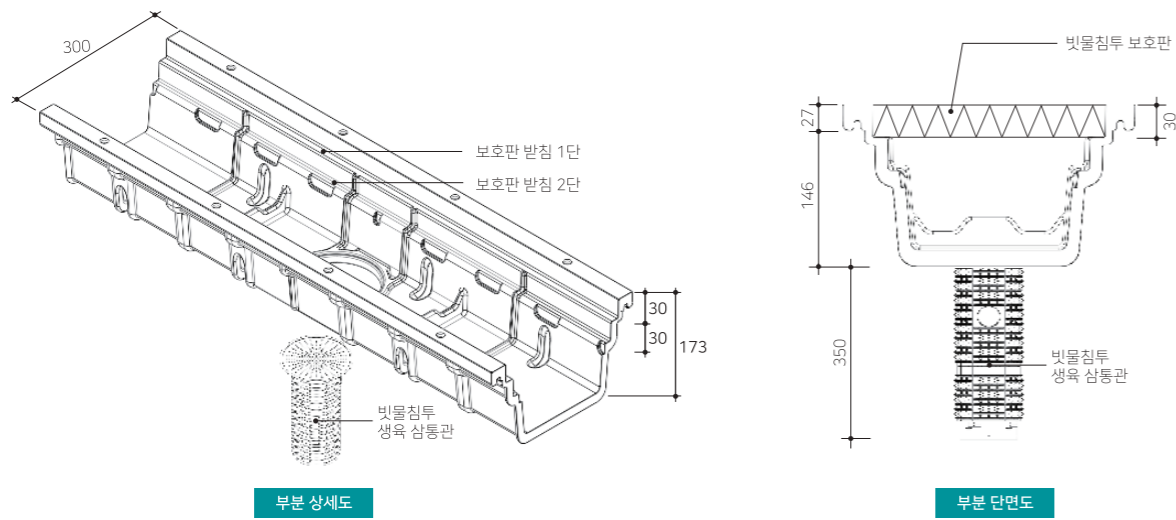

SMART GREEN CITY
스마트그린도시 10선



5

빗물저장
천연잔디보호매트

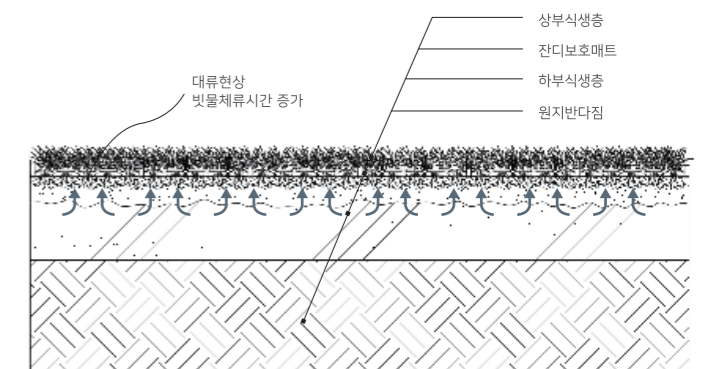

빗물저장 잔디보호매트 A type

제품명	빗물저장 잔디보호매트
규격	(W)400 x (L)600 x (H)34
재질	H.D.P.E L.D.P.E
용도	천연잔디 보호, 지반 녹화
기능	도시물순환 LID제품 -빗물저장 구조 -생태면적 확대 -미세먼지 저감 -열섬현상 완화 -휴식공간 조성

조달단가 37,000원~47,000원 / m² [81page]

물품식별번호 [나라장터] 우수제품
23647621

하부형

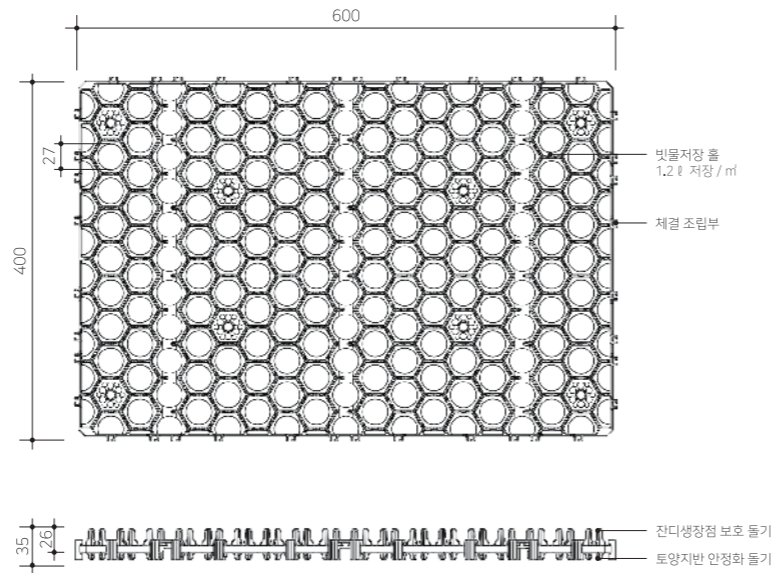

상세도면

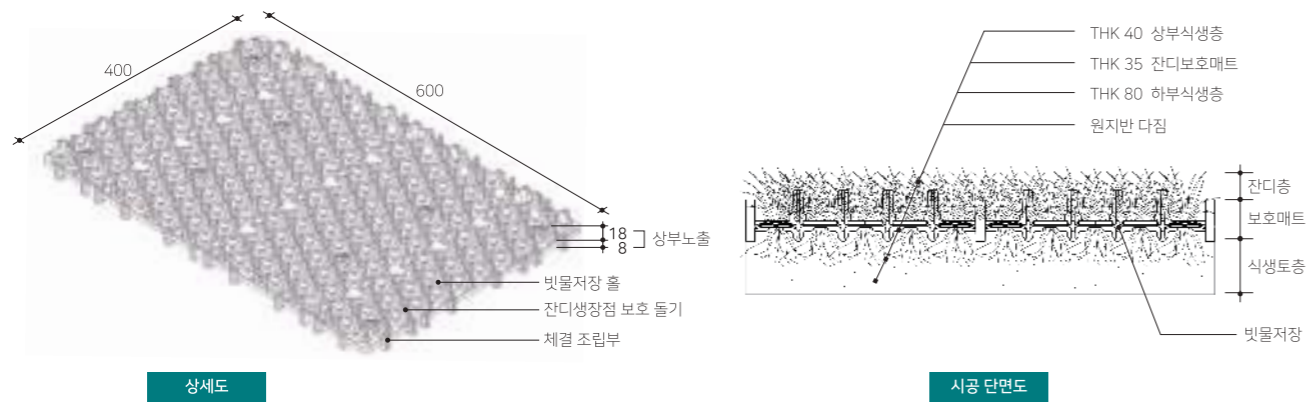



[공원·광장형] 경기도 수원시 노송공원 22' 3.



[옥상녹화] 서울시 용산구 한남빛물펌프장 20' 8.



[공원·광장형] 강원도 속초시 수복탑공원 19' 8.



[옥상녹화] 서울시 양천구 SBS직장어린이집 19' 7.



[산책로] 경기도 수원시 연화장 봉안당 19' 7.



[야영장] 서울시 한강 잠원지구 19' 8.



[산책로] 경기도 부천시 여월동소공원 21' 8.



[야영장] 창원시 성산구 장미근린공원 23' 2.



[골프장] 충북 영동군 남성대 골프장 19' 8.



[주차장] 서울시 한강 잠원지구 천연잔디 주차장 18' 7.



[골프장] 충북 음성군 레인보우힐스CC 19' 8.



[주차장] 강진군 평동리 146-7번지 마을주차장 23' 6.

빗물저장 잔디보호매트 B type

제품명	빗물저장 잔디보호매트
규격	(W)200 x (L)200 x (H)30 (W)400 x (L)400 x (H)30
재질	H.D.P.E
용도	천연잔디 보호, 지반 녹화
기능	도시물순환 LID제품 -빗물저장 구조 -생태면적 확대 -미세먼지 저감 -열섬현상 완화 -휴식공간 조성
조달단가	36,000원~43,000원 / m ²

상부형

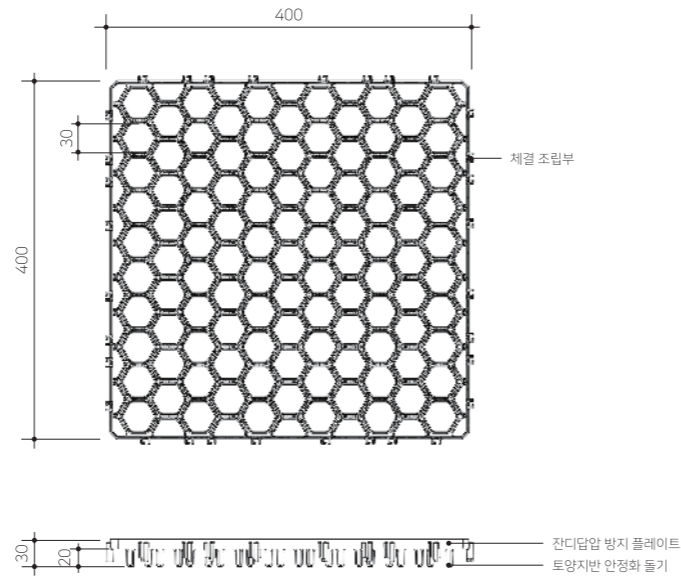

상세도면

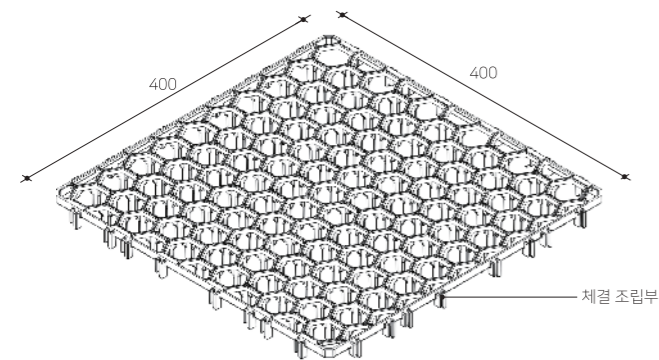

상세도

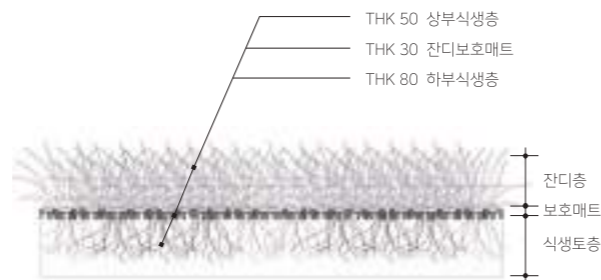

시공 단면도

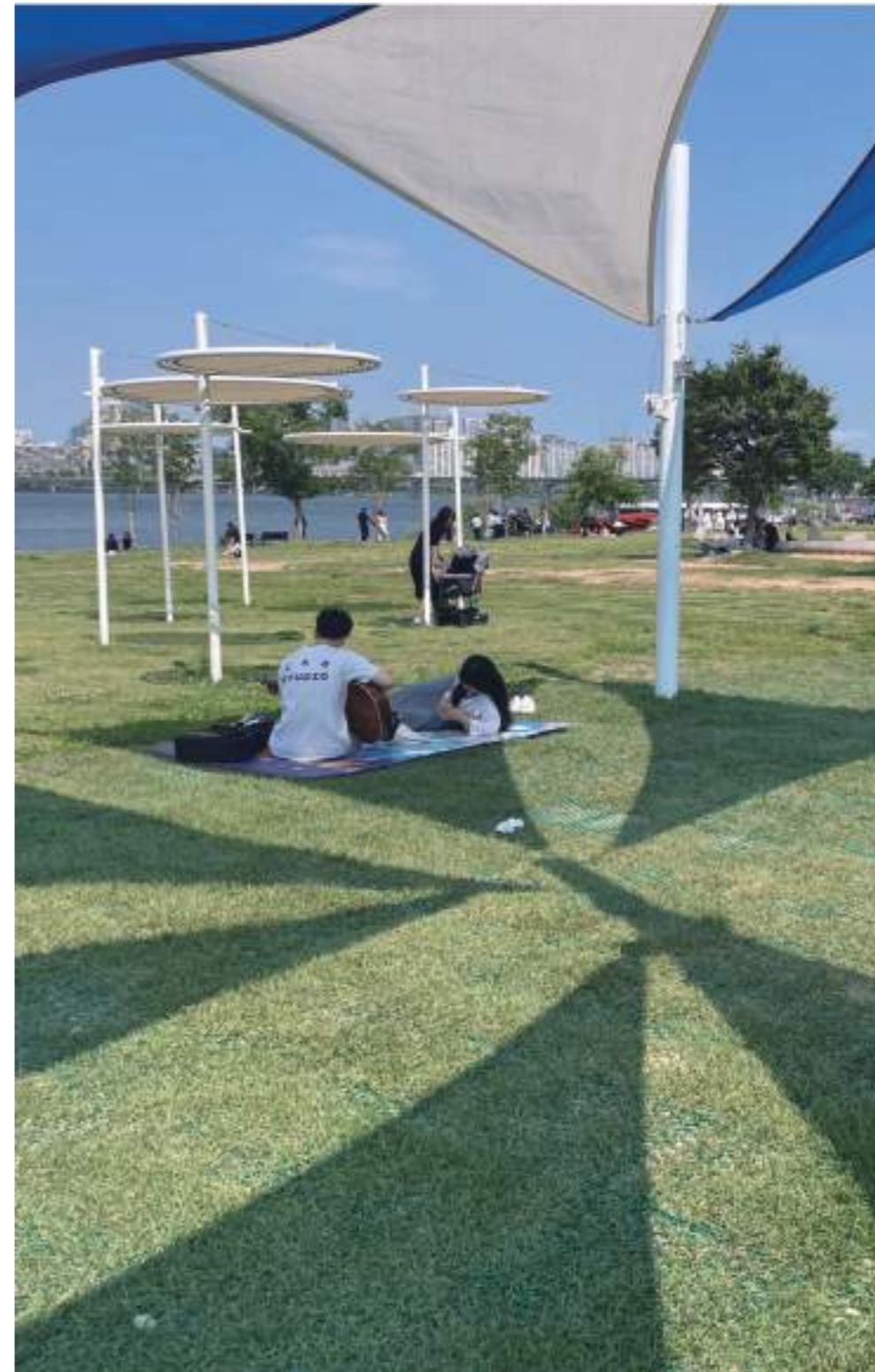
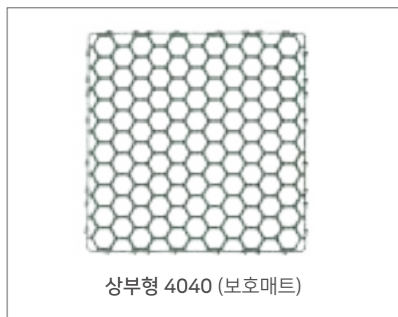



시공 직후 20' 11.

[공원] 서울시 서대문구 독립문공원 23' 6.



시공 직후 23' 2.

[공원] 순천 순천만국가정원 오천언덕 23' 5.



시공 직후 21' 12.

[공원] 서울시 여의도 한강시민공원 23' 6.



시공 직후 22' 6.

[공원] 대구 남구 앞산 뿔라터공원 23' 6.

SMART GREEN CITY
스마트그린도시 10선



6

빗물순환
빗물저금통

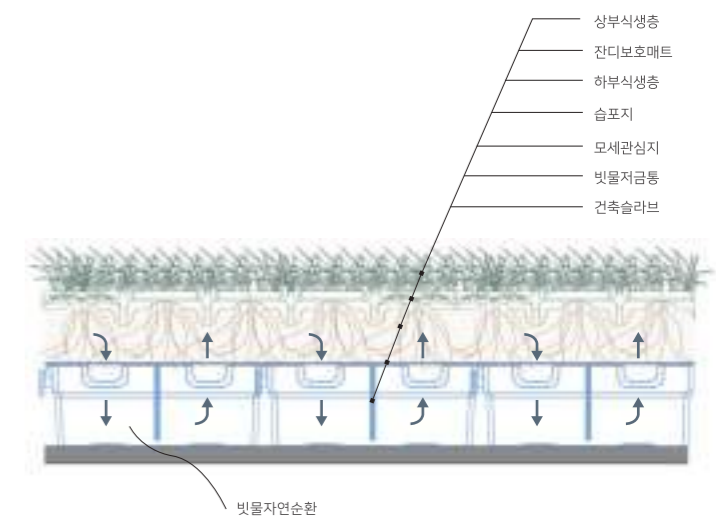

빗물순환 빗물저금통

제품명	빗물순환 빗물저금통
규격	(W)200 x (L)200 x (H)150 (W)400 x (L)400 x (H)100,150
재질	H.D.P.E 폐비닐재활용재 WV
용도	빗물 재이용 소형 저류조
기능	도시물순환 LID제품 -모듈형 연결구조 -빗물자원 순환 -미세먼지 저감 -열섬현상 완화
조달단가	164,000원~311,000원 / m ² [82page]
물품식별번호	[벤처나라], [혁신장터] 24123599 24400099~24400100

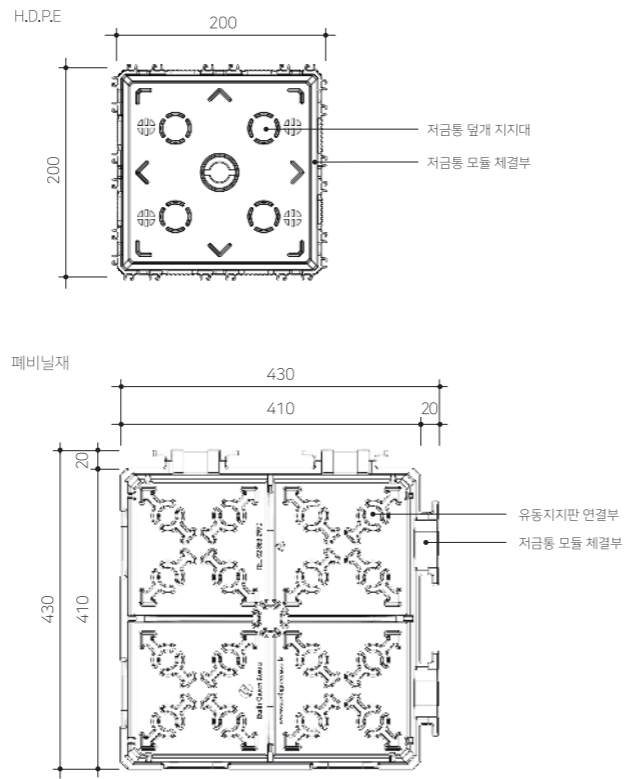

상세도면

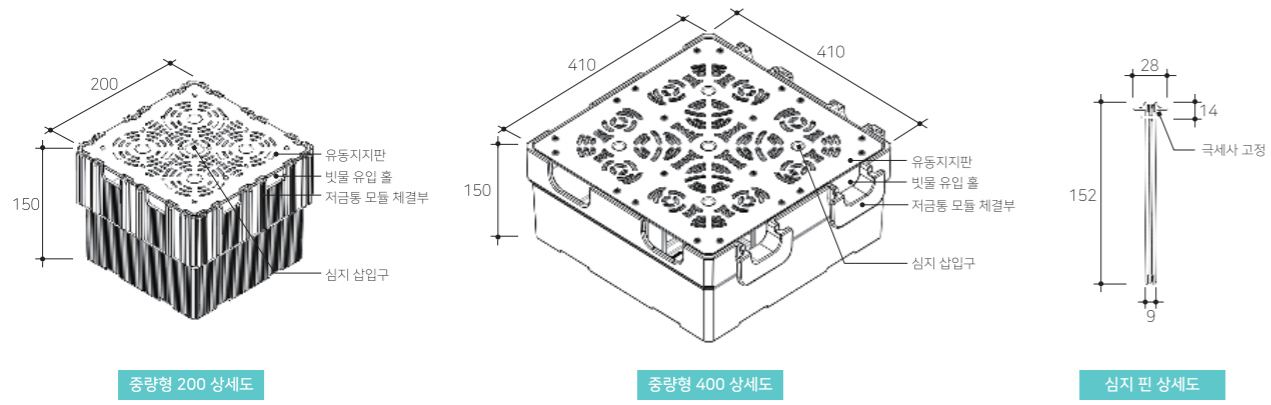

중량형 200 상세도

중량형 400 상세도

심지 핀 상세도



SMART GREEN CITY
스마트그린도시 10선



7

빗물순환
생태보행로 시스템

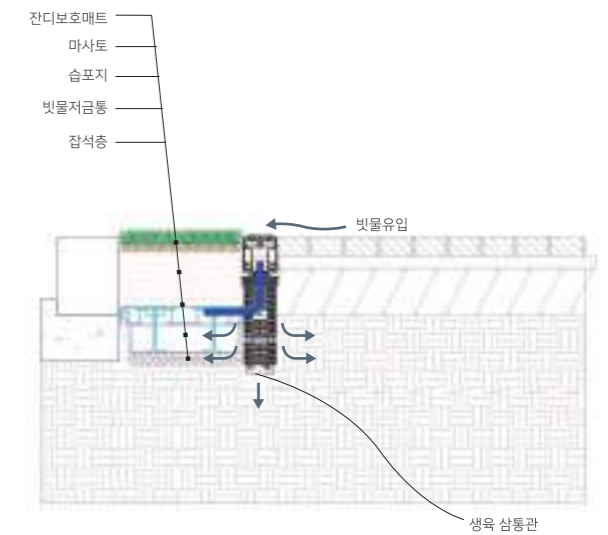

빗물순환 생태보행로 시스템

제품명 빗물순환 생태보행로 시스템

규격 (W)500 x (L)1,000 x (H)300
(W)700 x (L)1,000 x (H)300

재질 각 제품 해당 페이지 참고

용도 빗물자연순환 보행로 녹화

기능 도시물순환 LID제품
-친환경 물순환 체계 구축
-탄소저감, 공기질 향상
-생태형 녹지대 확대
-도시 열섬현상 완화

조달단가 248,000원~258,000원 / M [82page]

물품식별번호 [혁신장터]
24401842, 24401843

상세도면

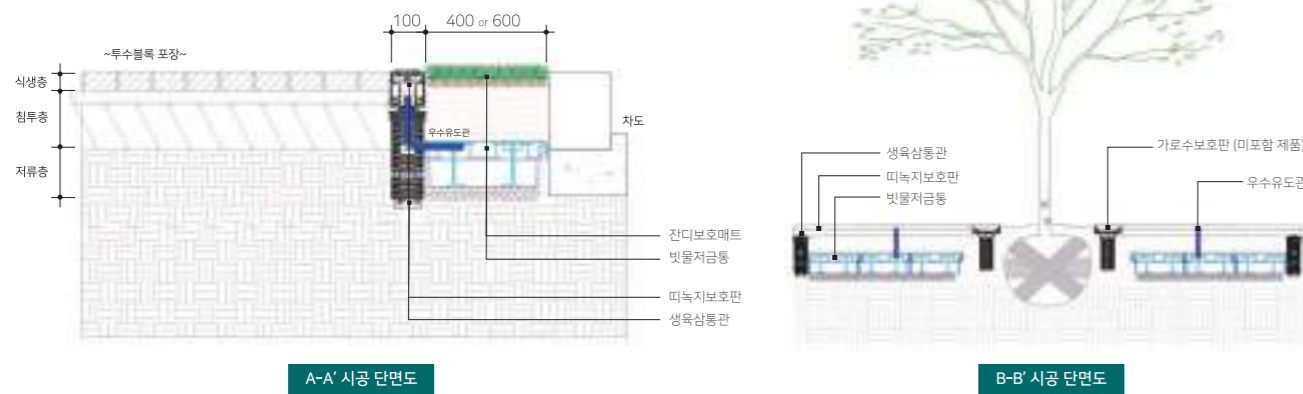

생태보행로 시스템 조달구매 포함 자재





시공 전

서울시 성동구 성동4차산업혁명체험센터 앞 23' 6.



시공 전

서울시 강서구 수명로 수명고등학교 앞 21' 10.



시공 전

서울시 강서구 등촌로 대일고등학교 앞 23' 7.



시공 전

서울시 강서구 개화동로 개화산역 앞 19' 10.



시공 전

서울시 성동구 독성역 사거리 22' 09.

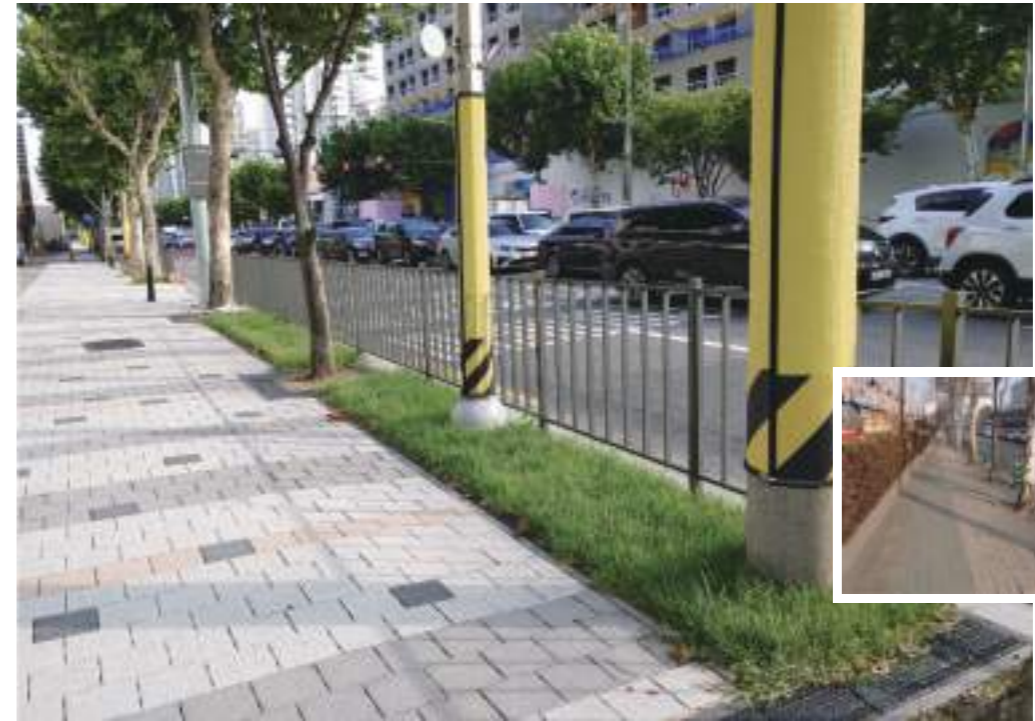

시공 전

서울시 구로구 경인로 기계공구상가 앞 22' 8.



시공 전

경기도 고양시 능곡동 행정복지센터 앞 21' 5.



시공 전

경기도 의정부시 환경자원센터 앞 21' 10.

SMART GREEN CITY
스마트그린도시 10선



8

빗물순환
옥상녹화 시스템

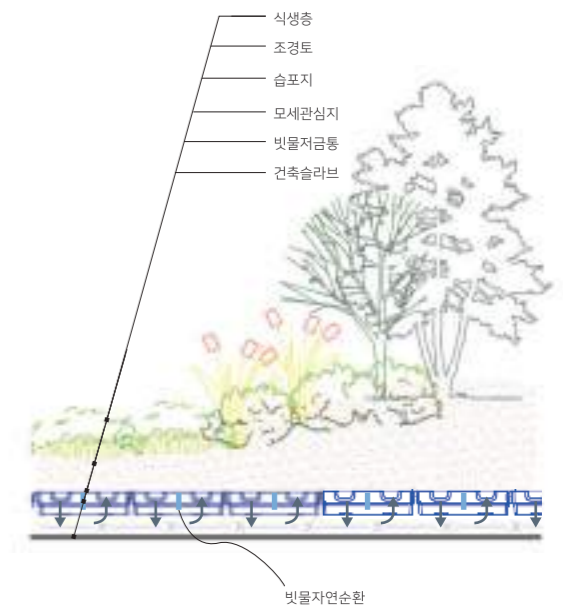

빗물순환 옥상녹화 시스템

제품명	IoT 기반 스마트 빗물순환 옥상녹화 시스템
규격	현장맞춤
재질	제품별 상이
용도	빗물자연순환 옥상녹화
기능	도시물순환 LID제품 -IoT 접목가능 -모듈형 연결구조 -온도저감, 소음흡착 -에너지 절감 효과
단가	190,000원~500,000원

상세도면

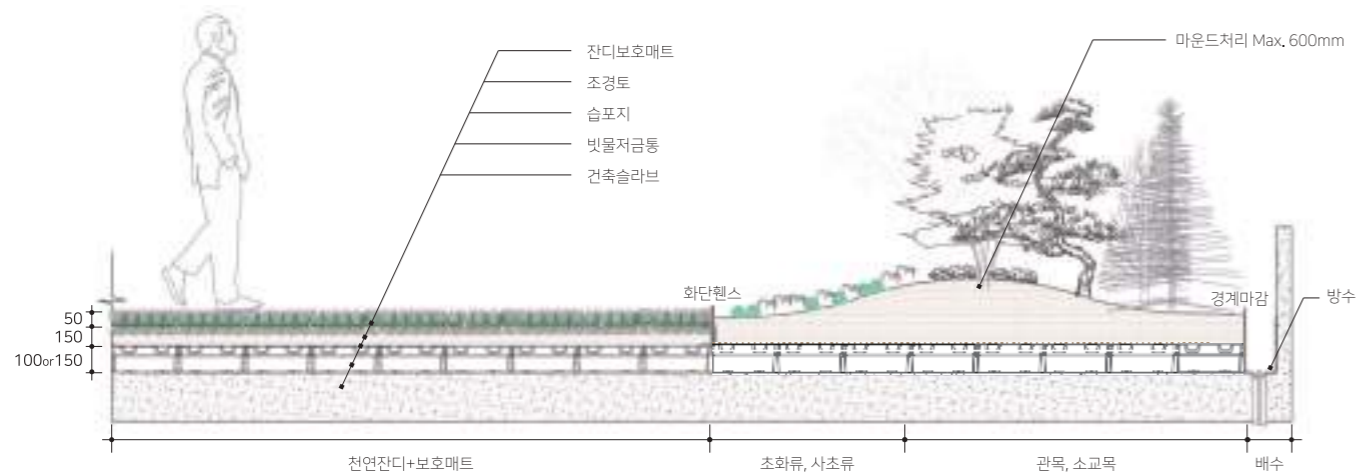
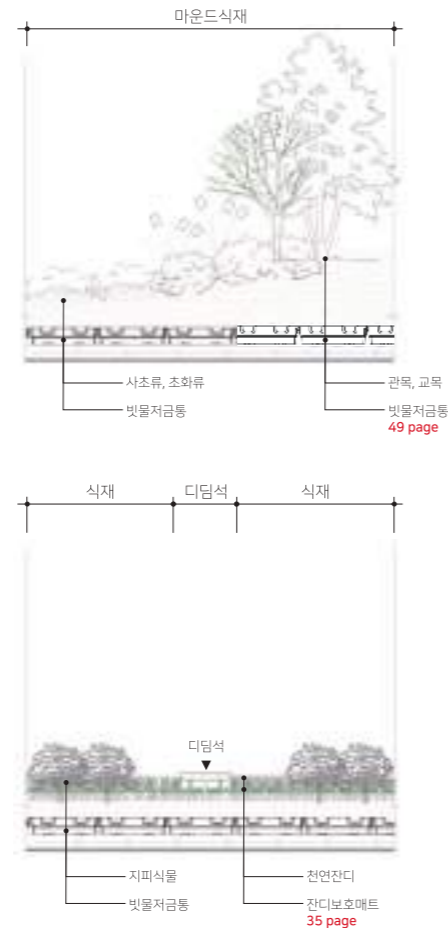

시공 단면도

옥상녹화 조성 과정



① 방수방근 (우레탄, 도막, 시트 선택) ② 빗물저금통과 물공급 호스 설치 ③ 수분유지 보온덮개 설치 ④ 토사 포설 후 잔디 및 식물 식재



여름



서울시 용산구 한남빗물펌프장 20' 8. 정원형 옥상녹화



겨울



서울시 용산구 한남빗물펌프장 21' 2. 정원형 옥상녹화

여름



서울시 서초구 농업기술센터 20' 8. 텃밭형 옥상녹화



겨울



서울시 서초구 농업기술센터 21' 2. 텃밭형 옥상녹화

SMART GREEN CITY
스마트그린도시 10선



9

빗물순환
천연잔디운동장 시스템

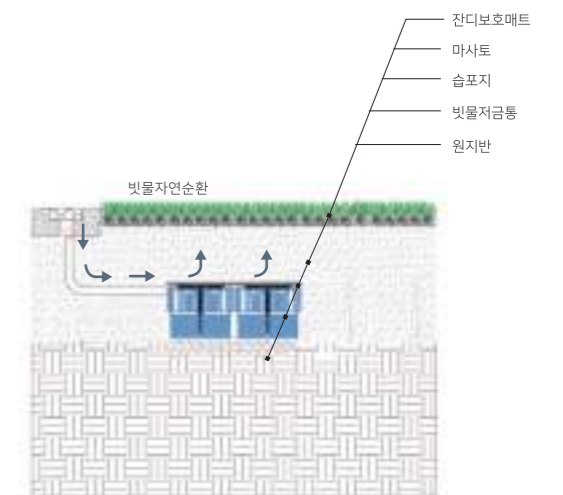

빗물순환 천연잔디운동장 시스템

제품명	빗물순환 천연잔디 운동장 시스템
규격	현장맞춤
재질	제품별 상이
용도	빗물자연순환 운동장 녹화
기능	도시물순환 LID제품 -저관리 운동장 녹화 -온도, 습도 조절 -화상, 부상 발생 저감 -사용자의 안전성 보장
단가	65,000원~277,000원

상세도면

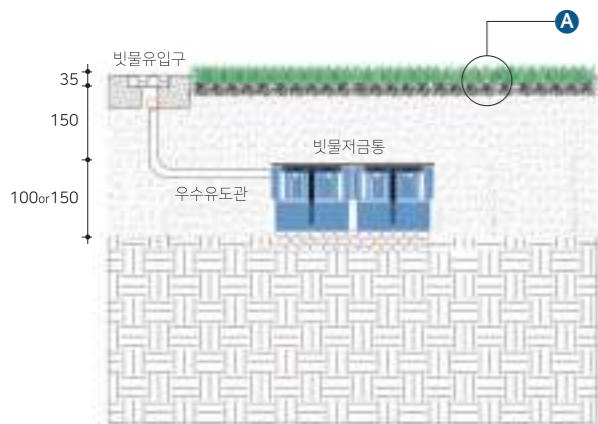
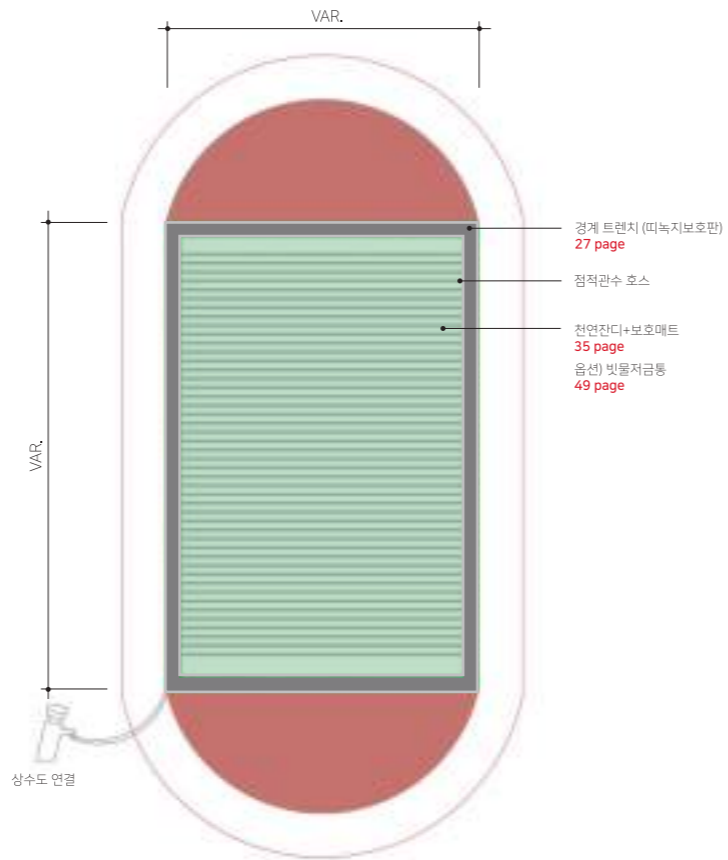

시공 단면도

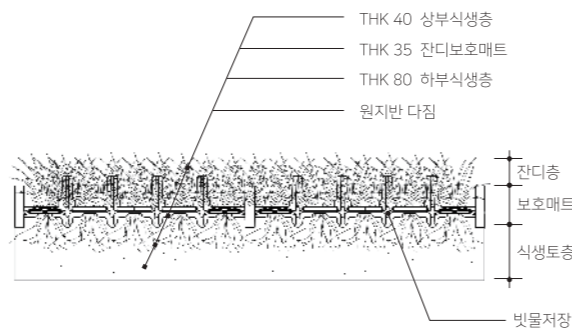

'A' 상세 단면도

천연잔디 운동장 조성 과정



① 지반평탄화 및 터파기 포크 작업 ② 빗물저금통과 물공급 호스 설치 ③ 수분유지 보온덮개 설치 ④ 토사 포설 후 보호매트와 잔디 압착





인천시 서구 인천체육고등학교 19' 10. 운동장 전체



강원도 홍천군 명덕초등학교 21' 7. 운동장 놀이터



서울시 강남구 도곡초등학교 20' 8. 운동장 보행로



서울시 영등포구 영원초등학교 21' 8. 운동장 돌레

SMART GREEN CITY
스마트그린도시 10선



10

빗물순환
벽면녹화 시스템

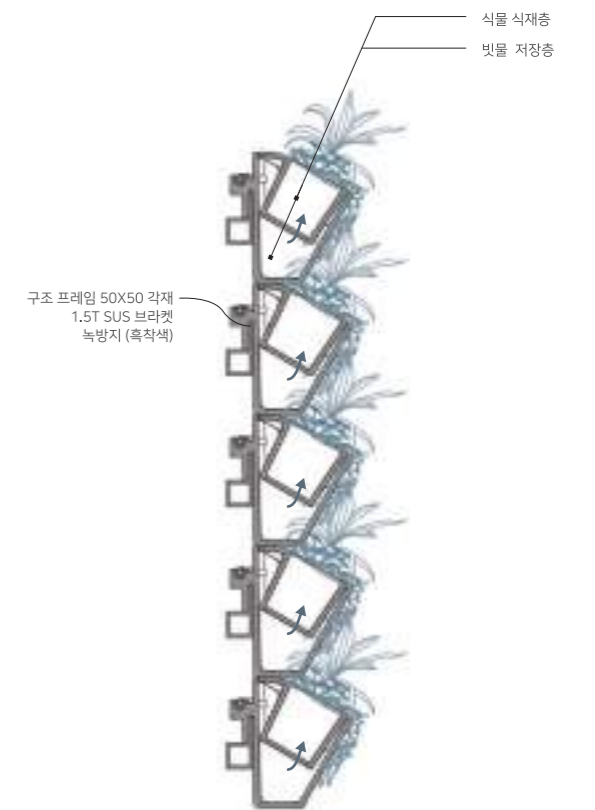

빗물순환 벽면녹화 시스템

제품명	빗물순환 벽면녹화 시스템
규격	현장맞춤
재질	제품별 상이
용도	빗물자연순환 수직녹화
기능	도시물순환 LID제품 -저관리 벽면녹화 -빗물 자연순환 시스템 -미세먼지 저감 효과 -소음 저감 효과
단가	150,000원~250,000원 / m ²

상세도면

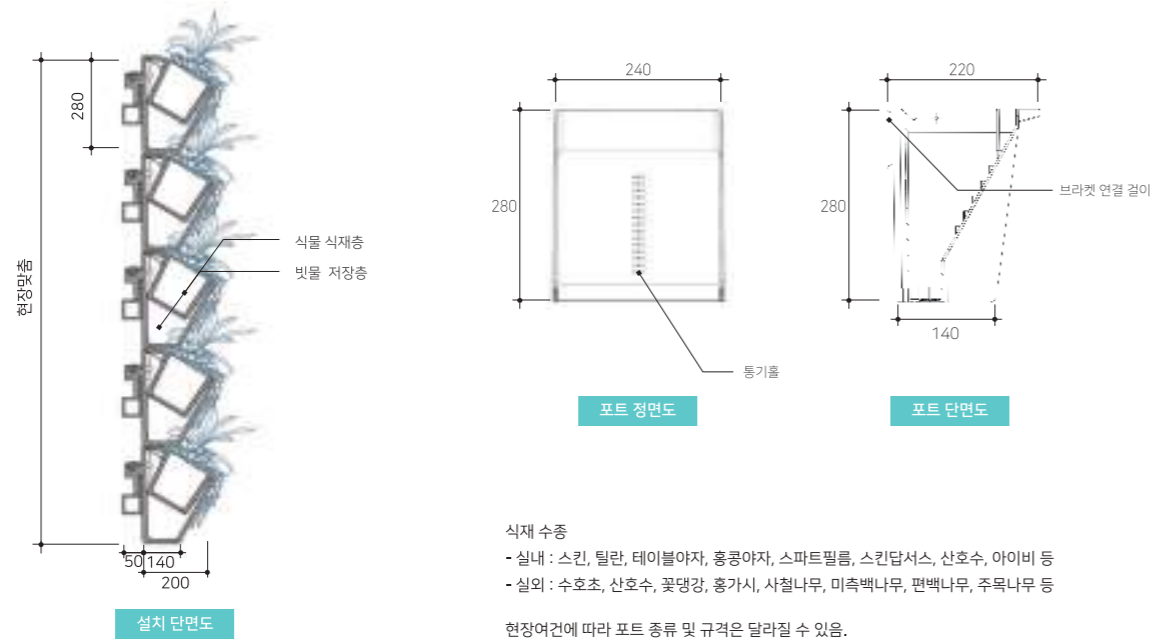

식재 수종
 - 실내 : 스킨, 틸란, 테이블야자, 홍콩야자, 스파트필름, 스킨답서스, 산호수, 아이비 등
 - 실외 : 수호초, 산호수, 꽃댕강, 홍가시, 사철나무, 미죽백나무, 편백나무, 주목나무 등
 현장여건에 따라 포트 종류 및 규격은 달라질 수 있음.

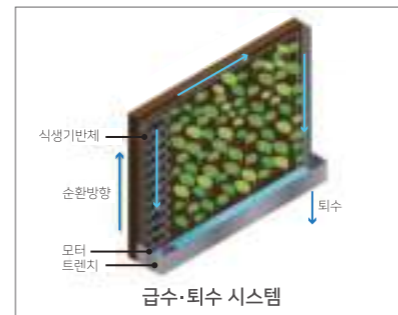



서울시 동대구 동대문구청 1층 실내 벽면녹화



서울시 중구 을지 트윈타워 850㎡ 실외 벽면녹화



경기도 화성시 어린이 문화센터 1층, 3층 실내 벽면녹화



서울시 영등포구 여의도 파크원(더현대서울) 1,650㎡ 실외 벽면녹화

조달구매 단가

LID 저영향개발 빗물활용 제품

제품상세 PAGE 07~12

쇼핑몰	구분	No	물품식별번호	품명	모델명	규격	단위	조달단가 (VAT 포함)
벤처나라	삼통관	1	22766994	급양, 급수관	EGK-PC-100S3 (일체형)	Ø100x300mm	개	5,700
		2	22766995	급양, 급수관	EGK-PC-100S4 (일체형)	Ø100x400mm	개	6,500
		3	22766996	급양, 급수관	EGK-PC-100S5 (일체형)	Ø100x500mm	개	7,300
		4	-	급양, 급수관	EGK-PC-100S6 (일체형)	Ø100x600mm	개	8,000
		5	-	급양, 급수관	EGK-PC-100S7 (일체형)	Ø100x700mm	개	8,800
		6	-	급양, 급수관	EGK-PC-100S8 (일체형)	Ø100x800mm	개	9,600
		7	-	급양, 급수관	EGK-PC-100S9 (일체형)	Ø100x900mm	개	10,600
		8	-	급양, 급수관	EGK-PC-100S10 (일체형)	Ø100x1000mm	개	11,700
		9	24414795	급양, 급수관	EGK-REV100S35 (조립형)	Ø120x350mm	개	6,800
		10	24414796	급양, 급수관	EGK-REV100S65 (조립형)	Ø120x650mm	개	8,600
		11	-	급양, 급수관	EGK-REV100S95 (조립형)	Ø120x950mm	개	12,000

보호판, 보호틀, 삼통관 세트 제품상세 PAGE 13~18

쇼핑몰	구분	No	물품식별번호	품명	모델명	규격	단위	조달단가 (VAT 포함)	
나라장터	일반형 HDPE	정사각형	1	23262343	가로수보호판	EGK-AL-1010SQ	1000x1000x80mm	조	304,400
			2	23262344	가로수보호판	EGK-AL-1111SQ	1100x1100x80mm	조	330,400
			3	23262345	가로수보호판	EGK-AL-1212SQ	1200x1200x80mm	조	396,300
			4	23262346	가로수보호판	EGK-AL-1313SQ	1300x1300x80mm	조	407,000
			5	23262347	가로수보호판	EGK-AL-1414SQ	1400x1400x80mm	조	440,800
			6	23262348	가로수보호판	EGK-AL-1515SQ	1500x1500x80mm	조	524,000
			7	23262349	가로수보호판	EGK-AL-1616SQ	1600x1600x80mm	조	542,000
			8	23262350	가로수보호판	EGK-AL-1717SQ	1700x1700x80mm	조	596,200
			9	23262351	가로수보호판	EGK-AL-1818SQ	1800x1800x80mm	조	658,300
			10	23262352	가로수보호판	EGK-AL-1919SQ	1900x1900x80mm	조	673,000
			11	23262353	가로수보호판	EGK-AL-2020SQ	2000x2000x80mm	조	747,000
	직사각형	12	23265256	가로수보호판	EGK-AL-1208 RT	1200x800x80mm	조	304,400	
		13	23262354	가로수보호판	EGK-AL-1210 RT	1200x1000x80mm	조	311,300	
		14	23262355	가로수보호판	EGK-AL-1510 RT	1500x1000x80mm	조	416,400	
		15	23262356	가로수보호판	EGK-AL-1512 RT	1500x1200x80mm	조	451,100	



보호판, 보호틀, 삼통관 세트 제품상세 PAGE 13~18

쇼핑몰	구분	No	물품식별번호	품명	모델명	규격	단위	조달단가 (VAT 포함)	
나라장터	일반형 REV	정사각형	1	24711240	가로수보호판	EGK-REV-AL-1010SQ	1000x1000x80mm	조	249,000
			2	24711241	가로수보호판	EGK-REV-AL-1111SQ	1100x1100x80mm	조	280,000
			3	24711242	가로수보호판	EGK-REV-AL-1212SQ	1200x1200x80mm	조	310,000
			4	24711243	가로수보호판	EGK-REV-AL-1313SQ	1300x1300x80mm	조	341,000
			5	24711244	가로수보호판	EGK-REV-AL-1414SQ	1400x1400x80mm	조	372,000
			6	24711245	가로수보호판	EGK-REV-AL-1515SQ	1500x1500x80mm	조	401,000
			7	24711246	가로수보호판	EGK-REV-AL-1616SQ	1600x1600x80mm	조	433,000
			8	24711247	가로수보호판	EGK-REV-AL-1717SQ	1700x1700x80mm	조	463,000
			9	24711248	가로수보호판	EGK-REV-AL-1818SQ	1800x1800x80mm	조	493,000
			10	24711249	가로수보호판	EGK-REV-AL-1919SQ	1900x1900x80mm	조	524,000
			11	24711250	가로수보호판	EGK-REV-AL-2020SQ	2000x2000x80mm	조	555,000
	직사각형	12	24711251	가로수보호판	EGK-REV-AL-1208RT	1200x800x80mm	조	233,000	
		13	24711252	가로수보호판	EGK-REV-AL-1210RT	1200x1000x80mm	조	276,000	
		14	24711253	가로수보호판	EGK-REV-AL-1510RT	1500x1000x80mm	조	318,000	
		15	24711254	가로수보호판	EGK-REV-AL-1512RT	1500x1200x80mm	조	343,000	



보호판, 보호틀, 삼통관 개별 구매 제품상세 PAGE 13~18

쇼핑몰	구분	No	물품식별번호	품명	모델명	규격	단위	조달단가 (VAT 포함)	
혁신장터	일반형 WV	정사각형	1	24318652	보호판	EGK-WV1-1010-SQ	1000x1000x80mm	78,000	
				23913602	보호틀	EGK-REV-1010 SQ-FR		141,000	
				22766994	급양, 급수관	EGK-PC100S3		5,700	
			2	24318651	보호판	EGK-WV1-1111-SQ	1100x1100x80mm	89,000	
					23913603	보호틀		EGK-REV-1111 SQ-FR	156,000
					22766994	급양, 급수관		EGK-PC100S3	5,700
			3	24318650	보호판	EGK-WV1-1212-SQ	1200x1200x80mm	100,000	
					23913604	보호틀		EGK-REV-1212 SQ-FR	171,000
					22766994	급양, 급수관		EGK-PC100S3	5,700
			4	24318649	보호판	EGK-WV1-1313-SQ	1300x1300x80mm	112,000	
					23913605	보호틀		EGK-REV-1313 SQ-FR	187,000
	22766994	급양, 급수관			EGK-PC100S3	5,700			
	5	24318648	보호판	EGK-WV1-1414-SQ	1400x1400x80mm	123,000			
			23913606	보호틀		EGK-REV-1414 SQ-FR	202,000		
			22766994	급양, 급수관		EGK-PC100S3	5,700		



쇼핑몰	구분	No	물품식별번호	품명	모델명	규격	단위	조달단가 (VAT 포함)	
핵심장터	일반형 W V	6	24318647	보호판	EGK-WV1-1515-SQ	1500x1500x80mm	조	134,000	
			23913607	보호틀	EGK-REV-1515 SQ-FR			217,000	
			22766994	급양, 급수관	EGK-PC100S3	Ø100x300mm	개	5,700	
		7	24318646	보호판	EGK-WV1-1616-SQ	1600x1600x80mm	조	145,000	
			23913608	보호틀	EGK-REV-1616 SQ-FR			233,000	
			22766994	급양, 급수관	EGK-PC100S3	Ø100x300mm	개	5,700	
		8	24318645	보호판	EGK-WV1-1717-SQ	1700x1700x80mm	조	156,000	
			23913609	보호틀	EGK-REV-1717 SQ-FR			248,000	
			22766994	급양, 급수관	EGK-PC100S3	Ø100x300mm	개	5,700	
		9	24318644	보호판	EGK-WV1-1818-SQ	1800x1800x80mm	조	167,000	
			23913610	보호틀	EGK-REV-1818 SQ-FR			263,000	
			22766994	급양, 급수관	EGK-PC100S3	Ø100x300mm	개	5,700	
		10	24318643	보호판	EGK-WV1-1919-SQ	1900x1900x80mm	조	178,000	
			23913611	보호틀	EGK-REV-1919 SQ-FR			278,000	
			22766994	급양, 급수관	EGK-PC100S3	Ø100x300mm	개	5,700	
		11	24318642	보호판	EGK-WV1-2020-SQ	2000x2000x80mm	조	189,000	
			23913612	보호틀	EGK-REV-2020 SQ-FR			294,000	
			22766994	급양, 급수관	EGK-PC100S3	Ø100x300mm	개	5,700	
		직사각형	12	24318641	보호판	EGK-WV1-1210-RT	1200x1000x80mm	조	89,000
				23913614	보호틀	EGK-REV-1210 RT-FR			156,000
				22766994	급양, 급수관	EGK-PC100S3	Ø100x300mm	개	5,700
			13	24318640	보호판	EGK-WV1-1510-RT	1500x1000x80mm	조	106,000
				23913615	보호틀	EGK-REV-1510 RT-FR			179,000
				22766994	급양, 급수관	EGK-PC100S3	Ø100x300mm	개	5,700
			14	24318639	보호판	EGK-WV1-1512-RT	1500x1200x80mm	조	117,000
				23913616	보호틀	EGK-REV-1512 RT-FR			194,000
				22766994	급양, 급수관	EGK-PC100S3	Ø100x300mm	개	5,700



쇼핑몰	구분	No	물품식별번호	품명	모델명	규격	단위	조달단가 (VAT 포함)	
나라장터	슬림형 REV	정사각형	1	24534456	가로수보호판	EGK-SL-1010SQ	1000x1000x60mm	개	314,000
			2	24657243	가로수보호판	EGK-SL-1111SQ	1100x1100x60mm	개	344,000
			3	24657244	가로수보호판	EGK-SL-1212SQ	1200x1200x60mm	개	374,000
			4	24657246	가로수보호판	EGK-SL-1313SQ	1300x1300x60mm	개	405,000
			5	24657247	가로수보호판	EGK-SL-1414SQ	1400x1400x60mm	개	435,000
			6	24657250	가로수보호판	EGK-SL-1515SQ	1500x1500x60mm	개	464,000
			7	24657251	가로수보호판	EGK-SL-1616SQ	1600x1600x60mm	개	494,000
			8	24657256	가로수보호판	EGK-SL-1717SQ	1700x1700x60mm	개	525,000
			9	24657257	가로수보호판	EGK-SL-1818SQ	1800x1800x60mm	개	555,000
			10	24657259	가로수보호판	EGK-SL-1919SQ	1900x1900x60mm	개	585,000
			11	24657261	가로수보호판	EGK-SL-2020SQ	2000x2000x60mm	개	615,000
		직사각형	12	24657262	가로수보호판	EGK-SL-1208RT	1200x800x60mm	개	298,000
			13	24657263	가로수보호판	EGK-SL-1210RT	1200x1000x60mm	개	341,000
			14	24657264	가로수보호판	EGK-SL-1510RT	1500x1000x60mm	개	381,000
			15	24657265	가로수보호판	EGK-SL-1512RT	1500x1200x60mm	개	407,000

쇼핑몰	구분	No	물품식별번호	품명	모델명	규격	단위	조달단가 (VAT 포함)
나라장터	띠녹지	1	23261146	가로수보호판	EGK-AL-LT-80 (부품)	80x80x80mm	m	35,400
		2	23262358	가로수보호판	EGK-AL-100-SAL	200x1000x80mm	m	104,100
		3	23262357	가로수보호판	EGK-AL-250-S	300x1000x80mm	m	115,400
		4	24504138	가로수보호판	EGK-SL100-S4	1000x100x100mm	m	147,000

쇼핑몰	구분	No	물품식별번호	품명	모델명	규격	단위	단가
핵심장터	띠녹지	1	24318654	가로수보호판	EGK-REV-100-S1	200x1000x82mm	m	86,000
			22766994	급양, 급수관	EGK-PC-100S3	Ø100x300mm	개	5,700
		2	24318653	가로수보호판	EGK-REV-200-S2	300x1000x82mm	m	93,000
			22766994	급양, 급수관	EGK-PC-100S3	Ø100x300mm	개	5,700
		3	24294879	가로수보호판	EGK-SL100-S3	1000x100x100mm	m	112,000
			22766994	급양, 급수관	EGK-PC-100S3	Ø100x300mm	개	5,700



천연잔디 별도 제품상세 PAGE 35~46

쇼핑몰	구분	No	물품식별번호	품명	모델명	규격	단위	조달단가 (VAT 포함)
나라장터	잔디보호매트	1	-	잔디보호매트	EGK-GR100-4040 (상부형/하차도)	400x400x30	m ²	36,000
		2	-	잔디보호매트	EGK-GR100-4040 (상부형/설치도)	400x400x30	m ²	43,000
		3	23647621	잔디보호매트	EGK-GR100-4060 (하부형/하차도)	400x600x34	m ²	37,000
		4	23647621	잔디보호매트	EGK-GR100-4060 (하부형/설치도)	400x600x34	m ²	47,000

제품상세 PAGE 49~50

쇼핑몰	구분	No	물품식별번호	품명	모델명	규격	단위	조달단가 (VAT 포함)
혁신장터	빗물저금통	1	24400100	옥상녹화용재	EGK-RS-W100 (하차도/옵선 미포함)	400x400x100mm	m ²	164,000
		2	24400100	옥상녹화용재	EGK-RS-W100 (설치도/옵선 포함)	400x400x100mm	m ²	197,000
		3	24400099	옥상녹화용재	EGK-RS-W150 (하차도/옵선 미포함)	400x400x150mm	m ²	174,000
		4	24400099	옥상녹화용재	EGK-RS-W150 (하차도/옵선 포함)	400x400x150mm	m ²	207,000

천연잔디 별도 제품상세 PAGE 53~58

쇼핑몰	구분	No	물품식별번호	품명	모델명	규격	단위	조달단가 (VAT 포함)
혁신장터	생태보행로	1	24401843	생태보행로 시스템	EGK-LID-W400	500x1000xH300	m	248,000
		2	24401842	생태보행로 시스템	EGK-LID-W600	700x1000xH300	m	258,000

S2B 학교장터

부록참고

쇼핑몰	구분	No	물품식별번호	품명	모델명	규격	단위	조달단가 (VAT 포함)
학교장터	그레이팅덮개	1	202307066725250	그레이팅덮개	EGK-REV-GC-3050 (하차도)	300x500x6T	개	25,300
		2	202307066725249	그레이팅덮개	EGK-REV-GC-4050 (하차도)	400x500x6T	개	31,900

부록참고

쇼핑몰	구분	No	물품식별번호	품명	모델명	규격	단위	조달단가 (VAT 포함)
나라장터 (예정)	그레이팅덮개	1	-	그레이팅덮개	EGK-REV-GC-2050 (하차도)	200x500x6T	개	17,600
		2	-	그레이팅덮개	EGK-REV-GC-2050 (설치도)	200x500x6T	개	25,300
		3	24982952	그레이팅덮개	EGK-REV-GC-3050 (하차도)	300x500x6T	개	25,300
		4	24982952	그레이팅덮개	EGK-REV-GC-3050 (설치도)	300x500x6T	개	28,000
		5	24982951	그레이팅덮개	EGK-REV-GC-4050 (하차도)	400x500x6T	개	31,900
		6	24982951	그레이팅덮개	EGK-REV-GC-4050 (설치도)	400x500x6T	개	34,600
		7	24982950	그레이팅덮개	EGK-REV-GC-20100 (하차도)	200x1000x6T	개	31,900
		8	24982950	그레이팅덮개	EGK-REV-GC-20100 (설치도)	200x1000x6T	개	34,600
		9	24982949	그레이팅덮개	EGK-REV-GC-30100 (하차도)	300x1000x6T	개	46,200
		10	24982949	그레이팅덮개	EGK-REV-GC-30100 (설치도)	300x1000x6T	개	48,900
		11	24982948	그레이팅덮개	EGK-REV-GC-40100 (하차도)	400x1000x6T	개	59,400
		12	24982948	그레이팅덮개	EGK-REV-GC-40100 (설치도)	400x1000x6T	개	62,100



